

Moulinex
mini compact

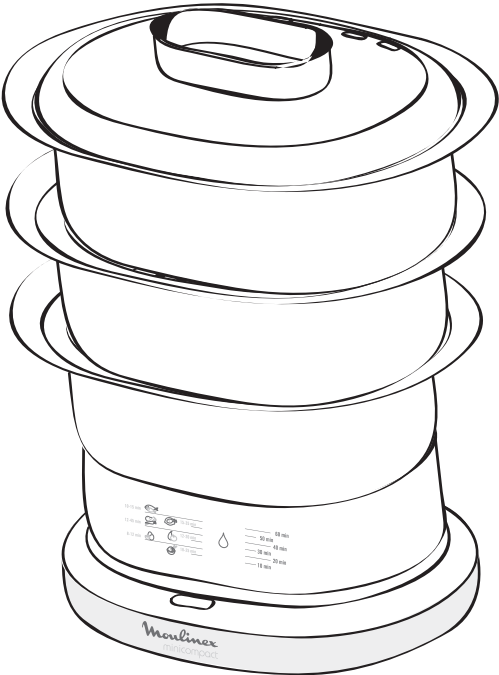

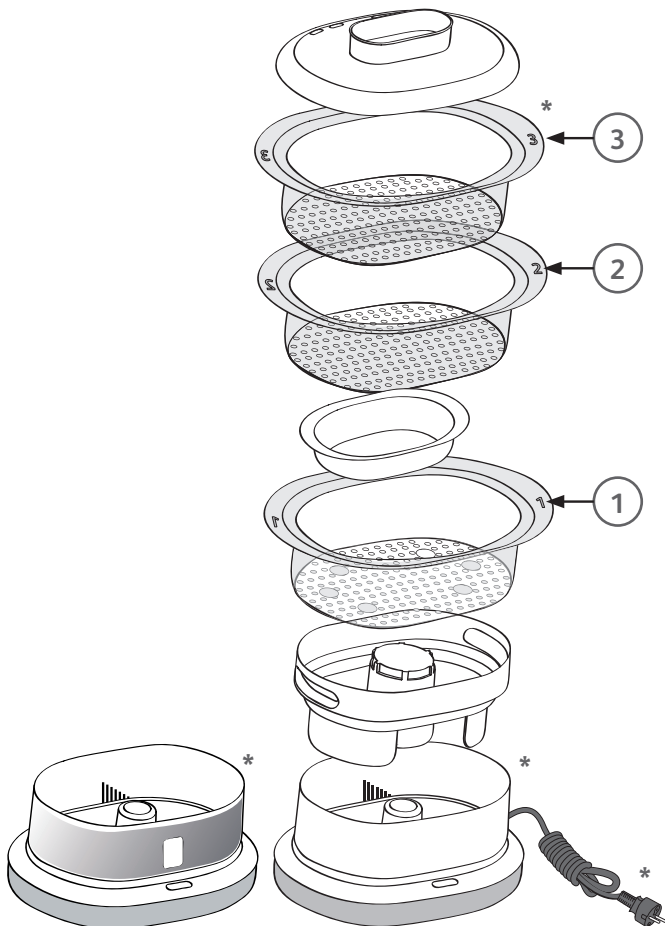

* Selon modèle - Afhankelijk van de model - Je nach Modell - Depending on model - Secondo il modello - Según modelo - Consoante o modelo - Ανάλογα με το μοντέλο - Modelle göre - Afhängigt af modellen - Beroende på modell - Avhengig av modell - Mallista riippuen - Ovisno o modelu - U zavisnosti od modela - Modelltöl fuggöen - Според модела - Odvisno od modela - Zależnie od modelu - Podle typu - Podľa typu - Bizonyos típusoknál - В зависимости от модели - Залежно від моделі - În funcție de model - Vastavalt mudelitele - Atbilstoši paraugiem - Pagal modelius - بحسب النموذج - بحسب مدل - 根据型号

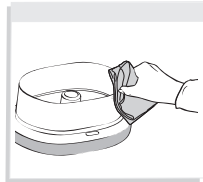
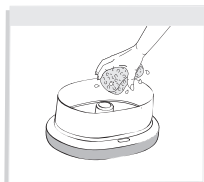
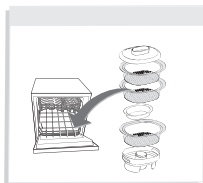

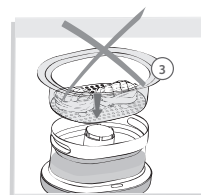
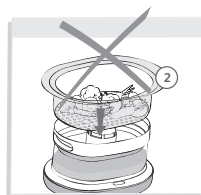
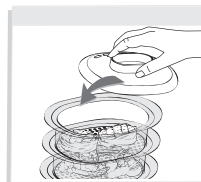
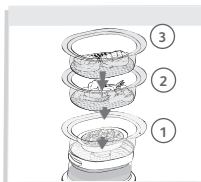
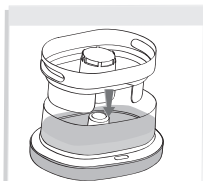
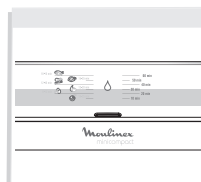
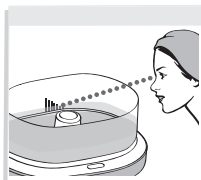
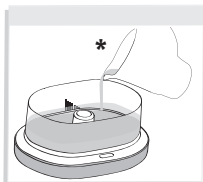
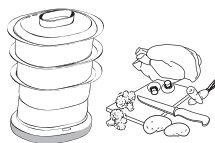

4 *Eau - Water - Wasser - Water - Acqua - Agua - Água - Нерó - Su - Vand - Vatten - Vann - Vesi - Voda - Voda - Voda - Вода - Woda - Woda - Voda - Voda - Víz - Вода - Вода - Арă - Vesi - Üdens - Vanduo - آب - ماء - 水

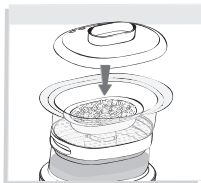
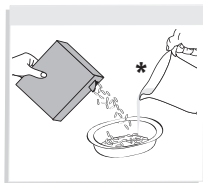

*Eau - Water - Wasser - Water - Acqua - Agua - Água - Νερό - Su - Vand - Vatten - Vann - Vesi - Voda - Voda - Voda - Voda - Voda - Voda - Viz - Вода - Вода - Apã - Vesi - Üdens - Vanduo - آب - ماء - 水

4

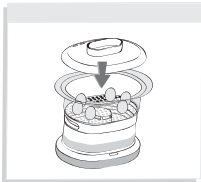
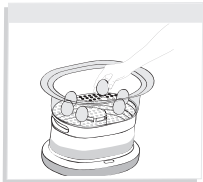
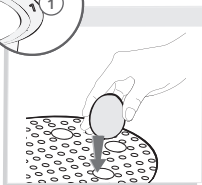
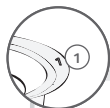

5

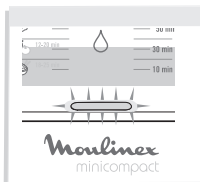
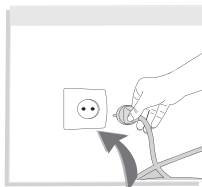
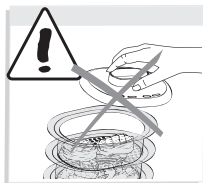
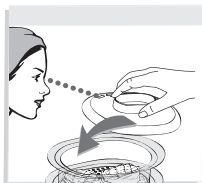

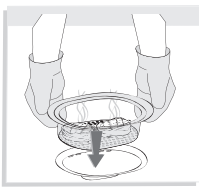
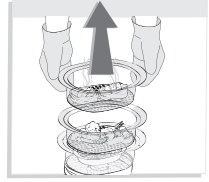
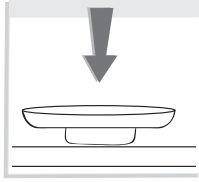
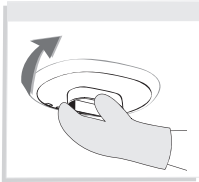
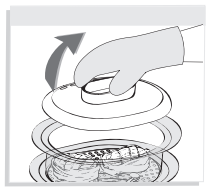
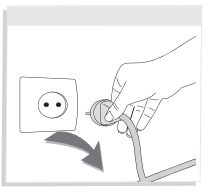
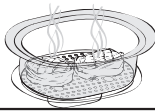

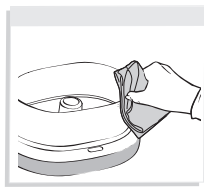
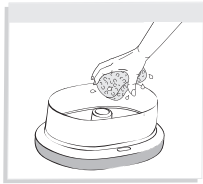
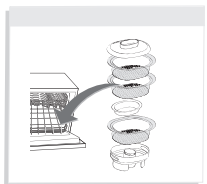
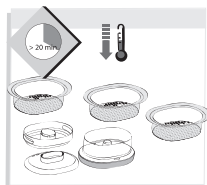



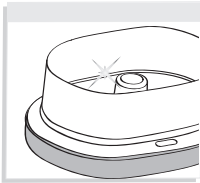
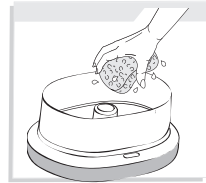
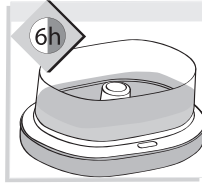
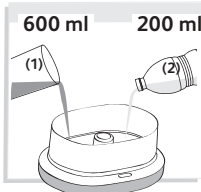



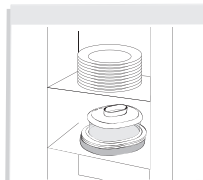
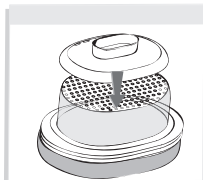
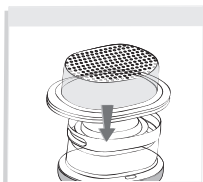
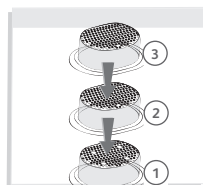
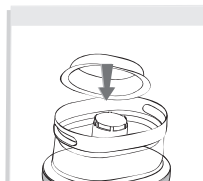
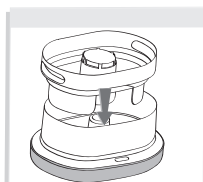























Toutes les 8 utilisations⁽³⁾



- (1) Eau - Water - Wasser - Water - Acqua - Agua - Água - Népó - Su - Vand - Vatten - Vann - Vesi - Voda - Voda - Voda - Вода - Voda - Woda - Voda - Voda - Víz - Вода - Вода - Apă - Vesi - Üdens - Vanduo - ماء - آب - 水
- (2) Vinaigre - Azijn - Essig - Vinegar - Aceto - Vinagre - Vinagre - Ξύδι - Sirke - Eddike - Ättiksblandning - Eddik - Etikka - Ocat ; Sirće - Vinsko sirće - Оцет - Kis - Ocet - Ocet - Ocot - Ecet - Уксус - Оцет - Ořet - Āādikas - Etiķis - Actas - سرکه - خل
- (3) Toutes les 8 utilisations - Na 8 keer gebruiken - Nach jeder 8. Ingebrauchnahme - Da controllare ogni 8 utilizzi - Cada 8 usos - Por cada 8 utilizações - Κάθε 8 χρήσεις - Her 8 kullanimda - Hver 8. gang apparatet tages i brug - Vid var 8:e användning - Etter hver åttende bruk - Joka 8. käyttökerta - Nakon svakih 8 uporaba - Nakon svakih 8 upotreba - След всяко 8 използване - Vsaka 8 uporaba - Po každych 8 użytkowników - Každých 8 roužití - Každých 8 roužití - Minden nyolcadik használat során - После каждых 8 использований - После каждых 8 применений - La fiecare 8 utilizări - Iga 8 kasutuskorra järel - Ik pēc 8 lietošanas reizēm - Po kiekvienų 8 naudojimų - كل ٨ استعمالات - هر ٨ استفاده می کند - 八种用途





			
		200 g	20 - 30 min
	 ***	200 g	20 - 30 min
		200/300 g	20 - 30 min
		200 g	20 - 30 min
		6	20 - 30 min
		125 g + 	30 - 40 min
		300 g	30 - 40 min
	 ***	300 g	40 - 50 min
		150 g	20 - 30 min
		300 g	50 - 60 min
		150 g	30 - 40 min
		300 g	50 - 60 min
	 ***	300 g	40 - 50 min
		300 g	30 - 40 min
		300 g	40 - 50 min
	 ***	300 g	50 - 60 min
		300 g	30 - 40 min
		300 g	30 - 40 min
		300 g	30 - 40 min
		300 g	30 - 40 min
		4	40 - 50 min
		4	30 - 40 min

(1) Eau - Water - Wasser - Water - Acqua - Agua - Água - Νερό - Su - Vand - Vatten - Vann - Vesi - Voda - Voda - Voda - Voda - Voda - Voda - Viz - Вода - Вода - Apä - Vesi - Üdens - Vanduo - آب - ماء - 水

Ref : NC00020278
Conception : www.batoteam.fr

