

*selon modèle • depending on model • je nach Modell • a seconda del modello • según modelo • consoante os modelos • Ανάλογα με το μοντέλο • В зависимости от модели • Залежно від моделі • zależnie od modelu • az egyes modellek szerint • podle modelů • podľa modelov • В зависимости от модели • În funcție de model • modellere göre • Зависно од модела • zavisno od modela • Őlede na model • بر حسب مدل • بحسب الموديل *

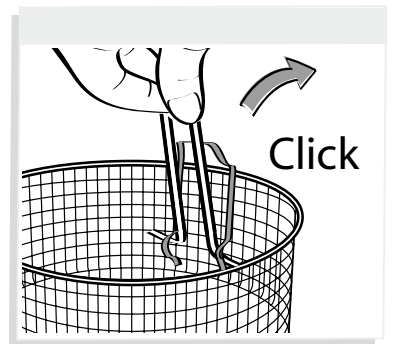

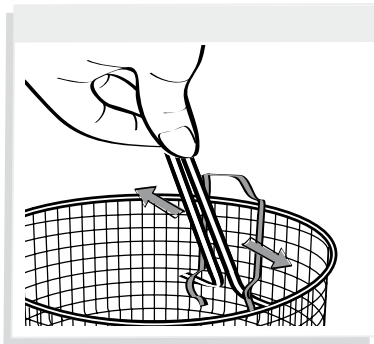

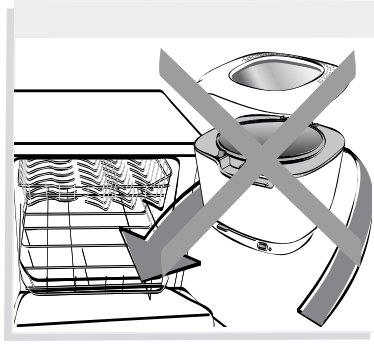
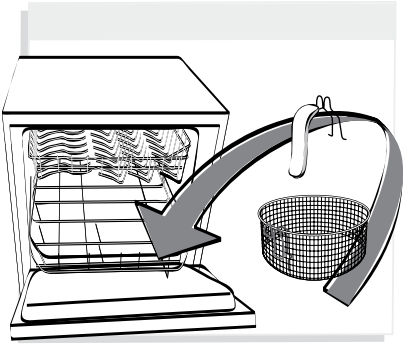
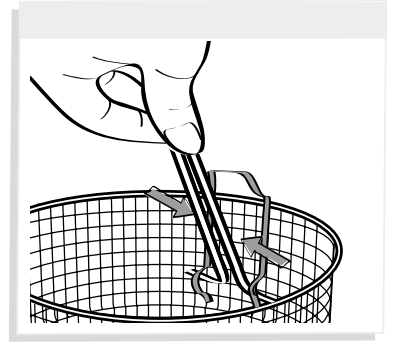
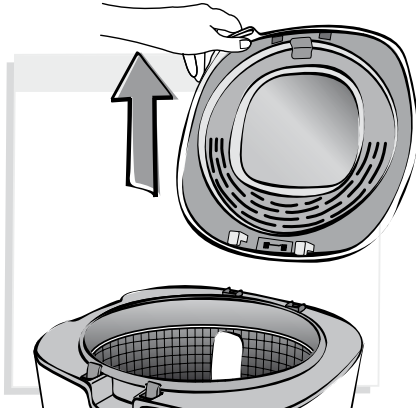
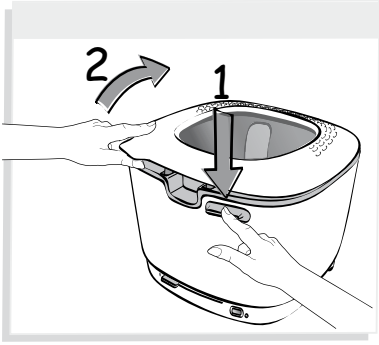
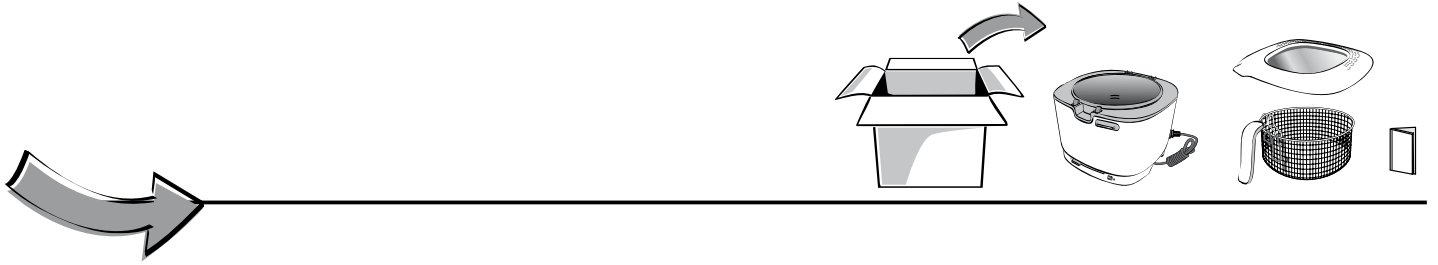

Min 1,6L

Max 1,8L

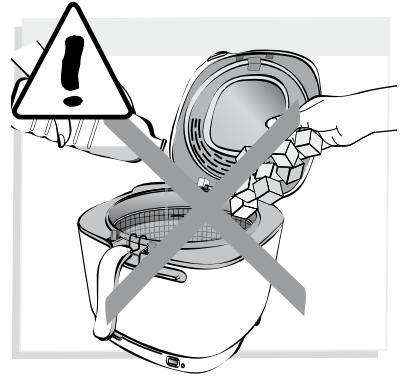
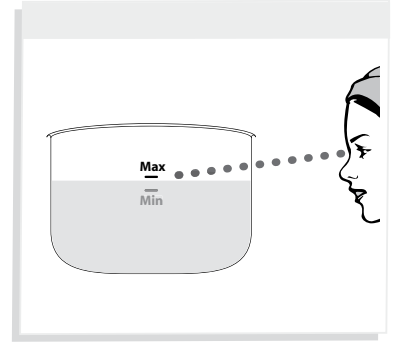

Min 1400g

Max 1600g

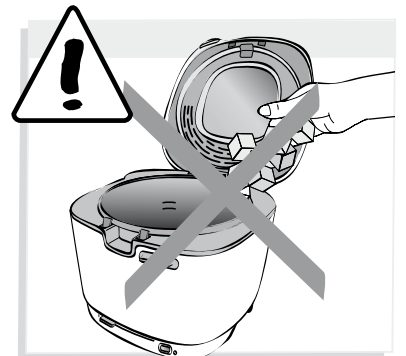
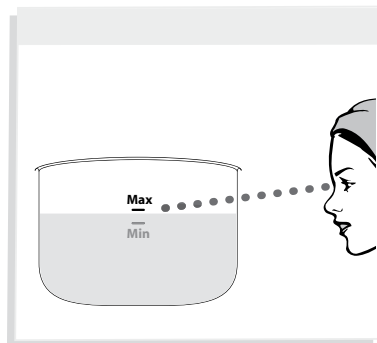
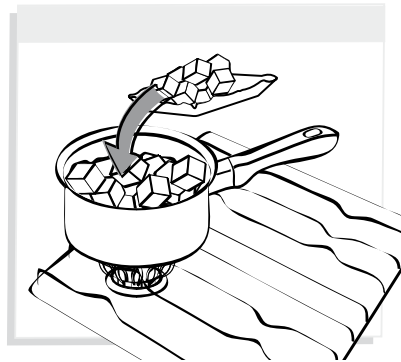

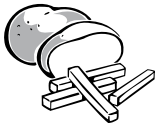

Max	800g
	500g

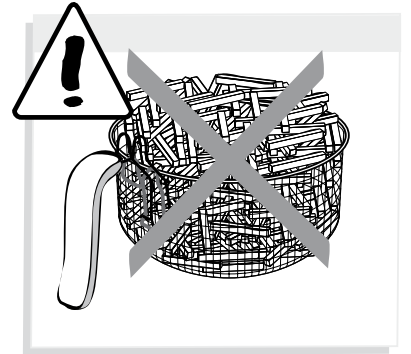
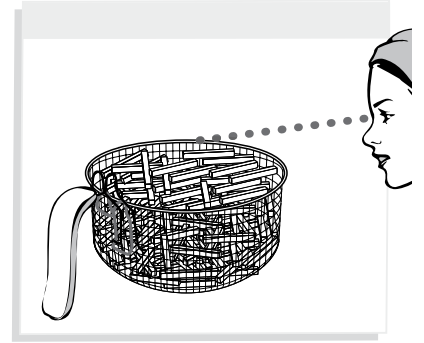
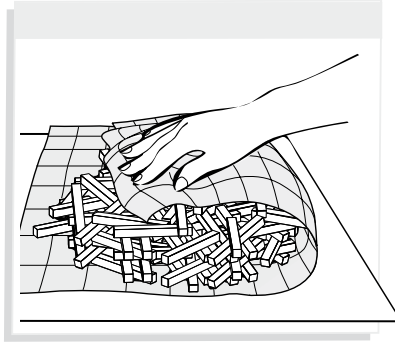

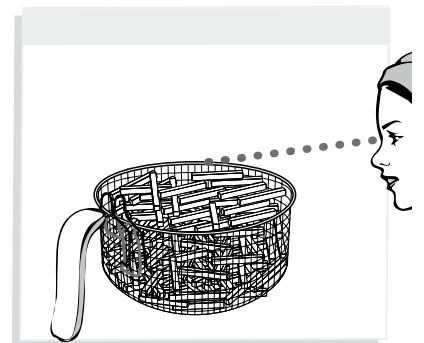
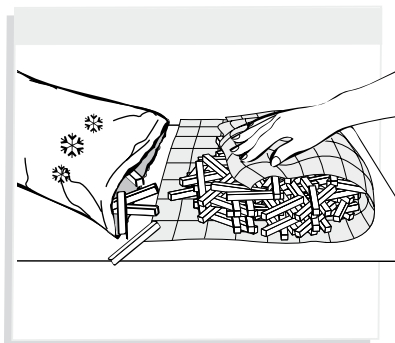

Max	750g
	380g

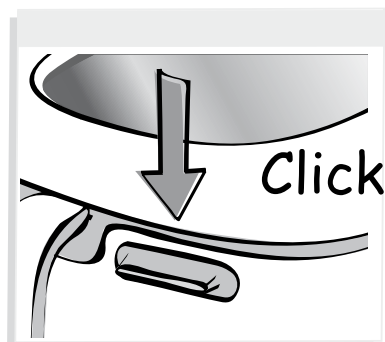
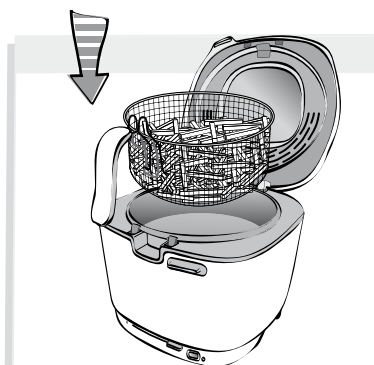
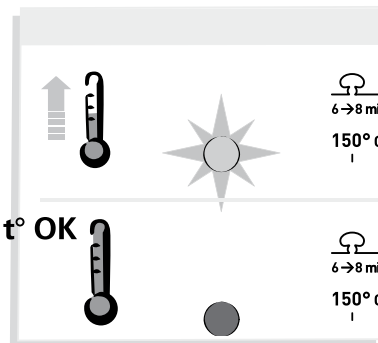
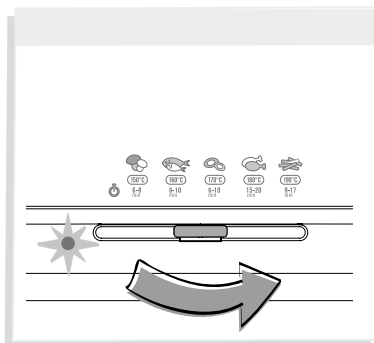
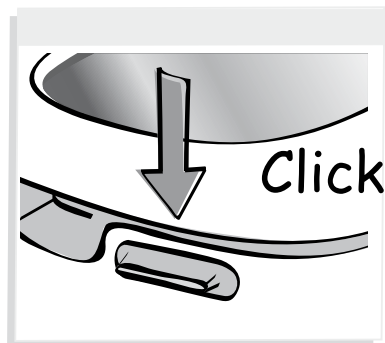
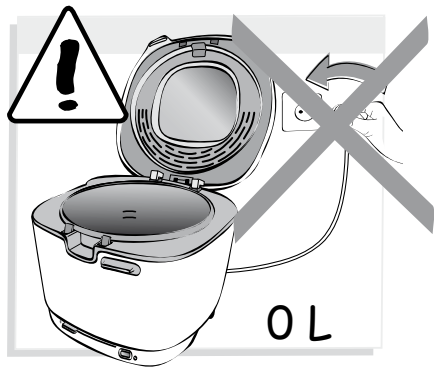

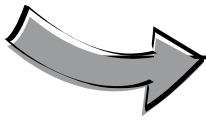



	Nb		°C	
		800g	1) 160°C	7-8 min.
			2) 190°C	5-6 min.
		800g	190°C	11-13 min.
		500g	190°C	8-10 min.
		3-4	180°C	15-20 min.
		2	160°C	8-10 min.
		8	150°C	6-8 min.
		10-12	180°C	8-10 min.
		500g	180°C	5-6 min.
		4	170°C	6-8 min.
* * *	Nb		°C	
		750g	190°C	11-13 min.
		380g	190°C	6-8 min.
		3-4	190°C	18-22 min.
		2	190°C	4-6 min.
		200g	190°C	4-6 min.
		1 Kg	190°C	7-8 min.
		5	190°C	4-5 min.

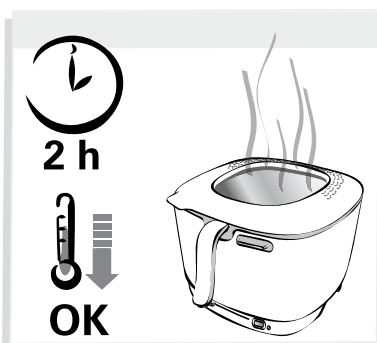
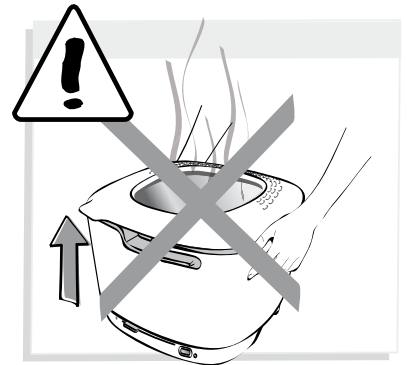
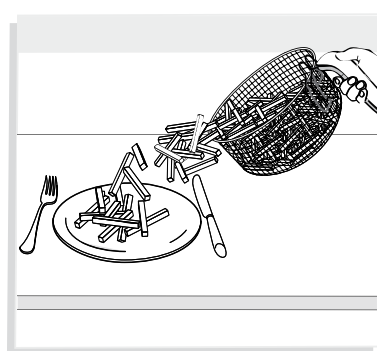
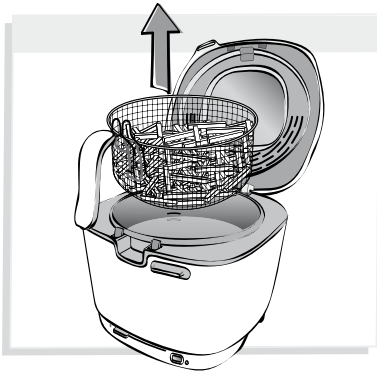
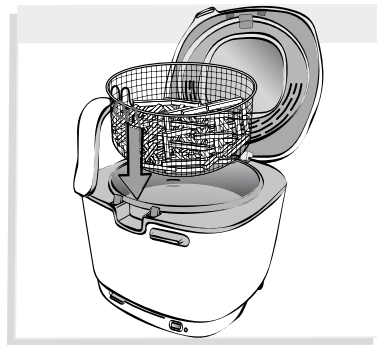
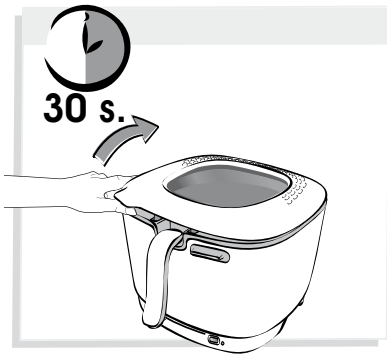
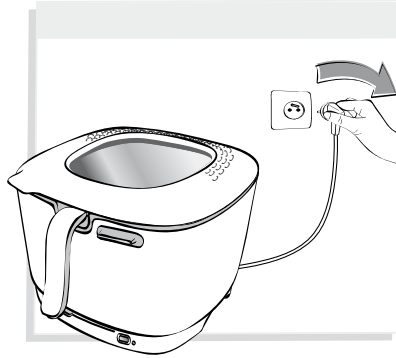
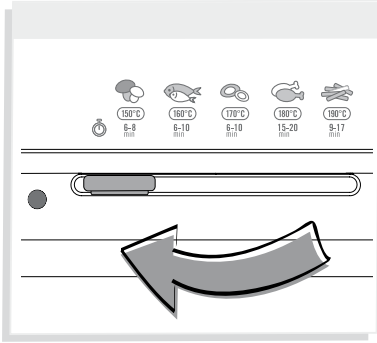
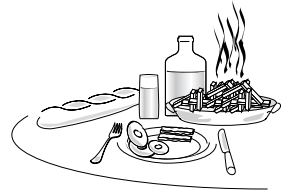

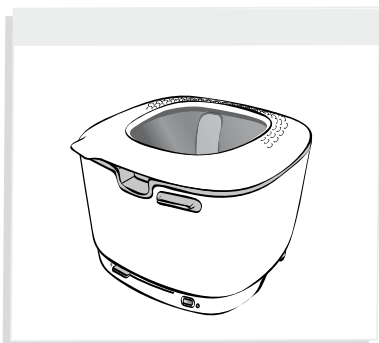
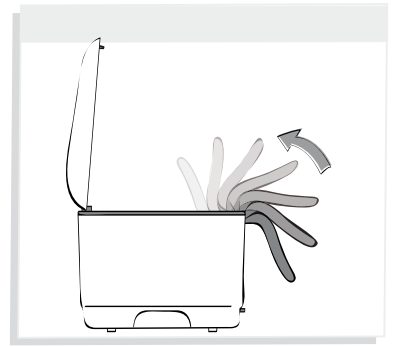
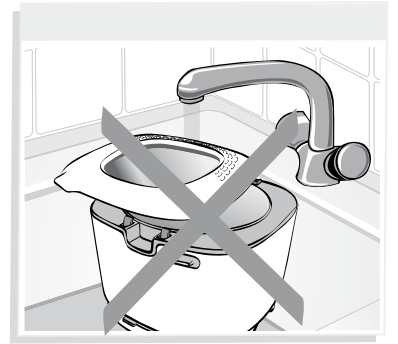
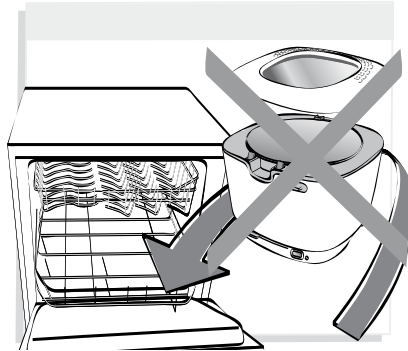
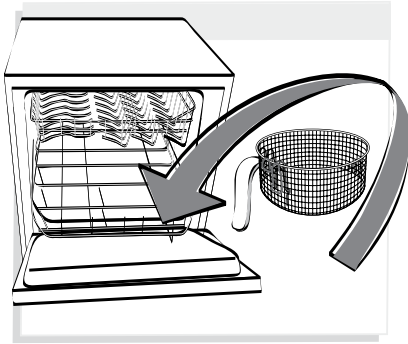
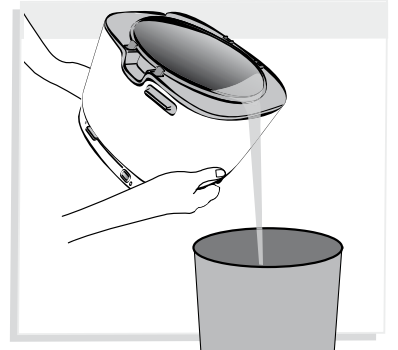
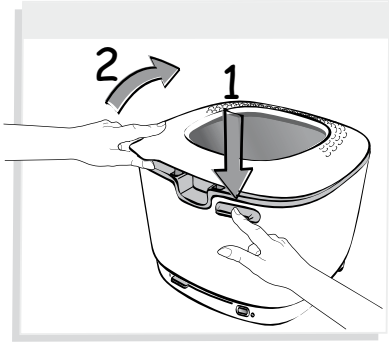
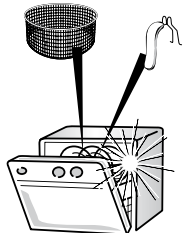

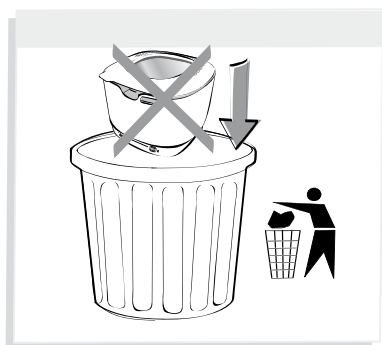
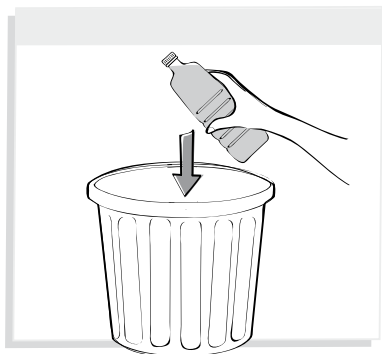
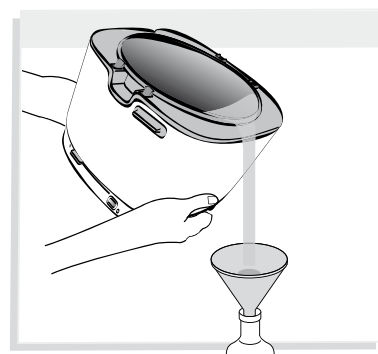
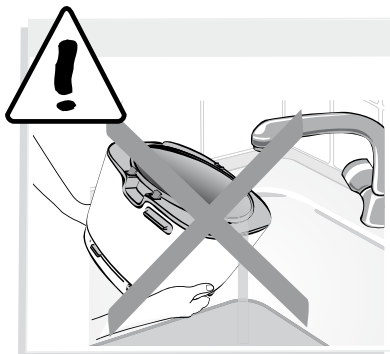

Référence : NC00018691
Conception : www.batoteam.fr

